

Article number: 201091645
 Description: E+G Lock pin
 GN 114.2-8-35

Measures

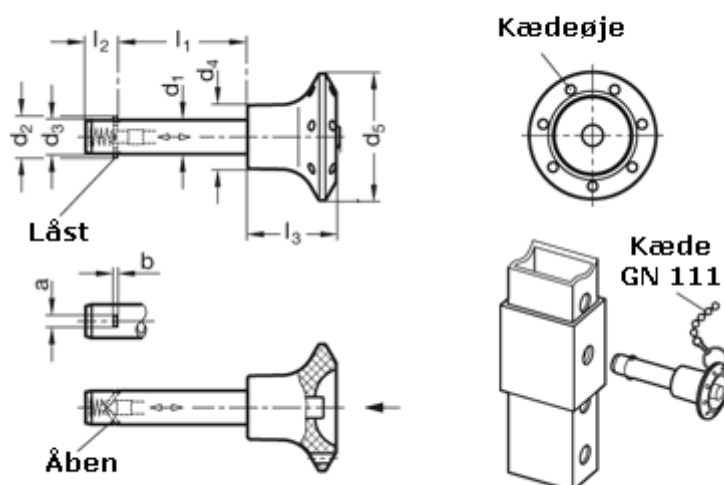

a	= 2,8	l1 = 35
b	= 1	l2 = 8,4
Clamping force (kN)	= 30	l3 = 21
d1	= 8	
d2	= 10,4	
d3	= 7,9	
d4	= 15	
d5	= 30	